



**Leaders
in marine
composite
fittings.**

Leaders in Marine Composite Fittings

**No Corrosion
No Electrolysis
No Worries**



Contents

04 Why Composites?

05 Skin Fittings

09 Ball Valves

15 Intake Strainers

17 Aquavalves / Y Valve

23 Threaded Connectors

28 Non-Return Valves

29 Vented Loops

31 Hose Connectors

35 Fastening Systems

36 Tank Sensors & Fittings

37 Nozzles

39 Installation Tools / Other

41 Compliance

43 Distributor Support



**Designed to
last the life
of your boat.**



TruDesign is a New Zealand based company with more than 45 years' experience in designing, tooling and the manufacturing of complex injection moulded composite fittings.

We offer a sophisticated range of marine products designed to last the life of your boat, whilst conforming to the rigid Bureau Veritas, ISO9093-2, IMCI and ABYC H-27 marine standards.

Our team is passionate about delivering high quality innovative products around the globe, this together with our exceptional technical support to our customers has enabled us to be a true leader in marine composite fittings.

Welcome to corrosion-free fittings by TruDesign.



Why Composites?

For many years, bronze has been the material of choice for use in underwater marine applications such as thru-hull fittings and seacocks. It outperformed many other metals and alloys and has stood the test of time. Until now...



Strong & Durable

Comply with ISO and ABYC mechanical properties, strength tests and UV requirements.

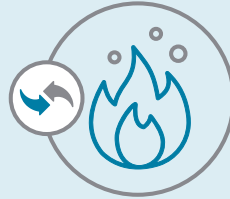

Flame Retardant

Can be used in engine compartments.



Light Weight

6 to 1 weight saving over bronze.

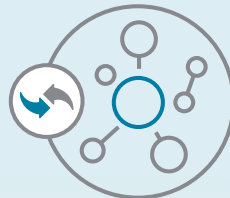

No Bonding

No need for expensive wiring of thru hull fittings.



Non Corrosive

No electrolysis giving peace of mind with respect to the safety of your boat.





Skin Fittings (Thru-Hulls)

Designed and made in New Zealand, TruDesign Skin Fittings (Thru Hulls) are precision moulded from glass-reinforced Nylon composite.

Certified to ISO 9093-2 by Bureau Veritas and the International Marine Certification Institute (IMCI, Belgium).

Complies with ABYC H-27 standards when used in conjunction with the TRUDESIGN™ ABYC collar.

TruDesign Skin Fittings (Thru Hulls) eliminate all corrosion and bonding problems associated with electrolysis giving peace of mind with respect to the safety of your vessel.

Features:

- Compatible with all hull types – Can be used on aluminium, steel, wood, composite & GRP hulls
- Chemical resistant – Unaffected by diesel, petrol, house-hold chemicals, and antifouling paints
- U.V resistant – Will not degrade or discolour from the sun's ultraviolet rays
- Paintable – Paintable with all types of antifoul including Coppercoat™
- Fits TruDesign Ball Valves. Two types of thread: Parallel BSP or NPS threads.
- Recessed and domed models.
- Large operating range – Suitable for all marine conditions from -40°C to +110°C

Recessed

Countersunk style head for a streamlined look.

Features:

- Reduced drag
- Flush mount to reduce possibility of snagging
- Can be used as cockpit/tank drain
- BSP and NPS parallel threads

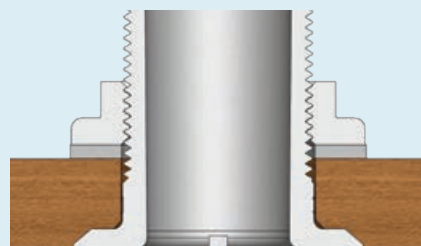

Domed

Traditional dome shaped head for easy installation.

Features:

- Large sealing face
- Protects end grain for timber construction
- Provides a drip edge for above water applications
- BSP and NPS parallel threads

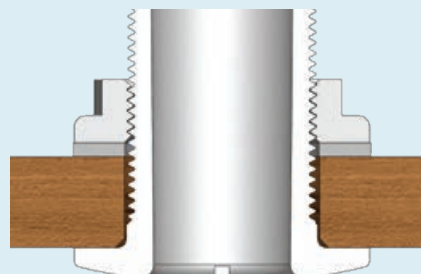

Standard Skin Fittings (Thru-Hulls)

Skin Fittings Domed

Thread Size Inside flange length

1/2" 66mm

3/4" 66mm

1" 66mm

1 1/4" 86mm

1 1/2" 84mm

2" 90mm

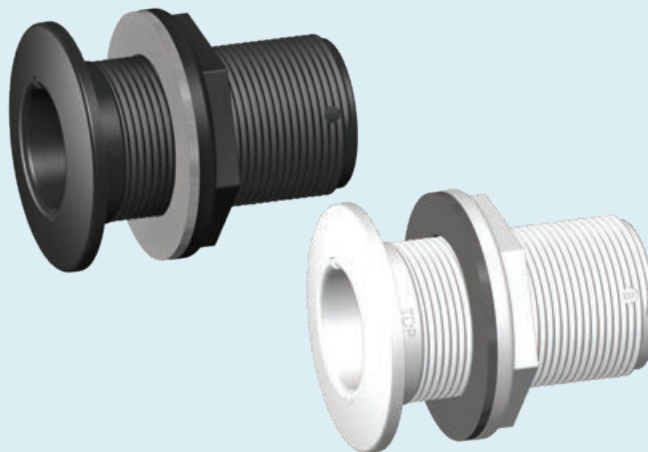

BSP NPS

Skin Fittings Recessed

Thread Size Inside flange length

1/2" 70mm

3/4" 70mm

1" 70mm

1 1/4" 90mm

2" 90mm

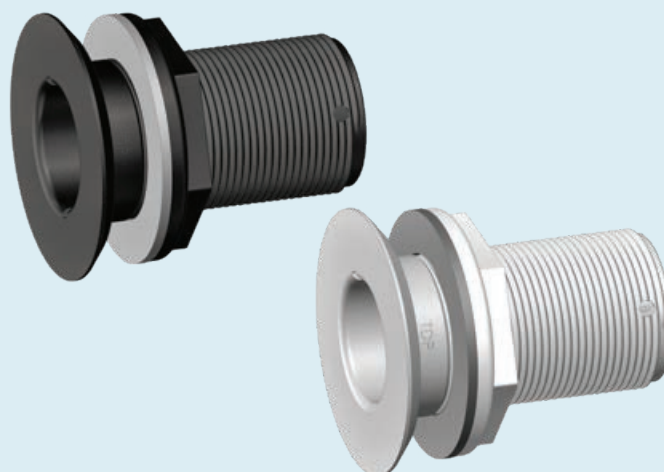

BSP NPS

Skin Fittings with Tail

Thread Size Tail Size

1/2" 13mm

1/2" 16mm (5/8")

3/4" 19mm

1" 25mm

1" 28mm (1 1/8")

1 1/4" 32mm

1 1/2" 38mm

2" 50mm

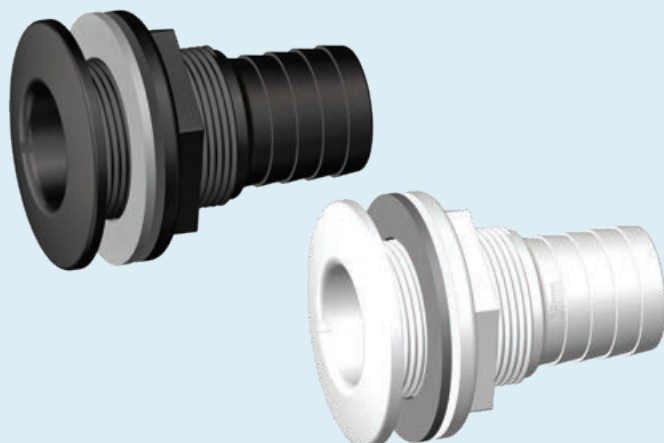

BSP

Long Skin Fittings (Thru-Hulls)

BSP

Skin Fittings Long / Domed

Thread Size	Inside flange length	Min hull thickness
3/4"	140mm	33mm
1"	140mm	33mm
1 1/4"	140mm	33mm
1 1/2"	140mm	33mm
2"	140mm	33mm
3"	160mm	33mm

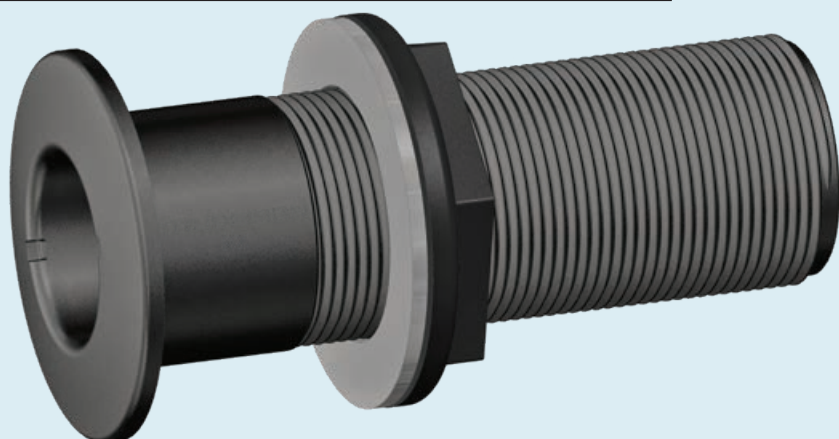

TruDesign thread forms

1. BSP(P) - British Standard Pipe (Parallel) - used widely throughout most parts of the world including Europe, Asia and Australasia.

Identified on TruDesign threaded fittings with a 'B'.

BSP

BSP (British Standard Pipe)

2. NPS - National Pipe Straight (American National Pipe) - predominantly used within North America.

Identified on TruDesign threaded fittings with an 'N'.

NPS

NPS (National Pipe Straight)

**Our products
are approved
by the toughest
global certification
authorities and
are supported
by a dedicated
engineering
team.**



Ball Valves (Seacocks)

TruDesign Ball Valves control thru-hull inlet and outlet requirements, above and below the water line. They are moulded in a lightweight glass-reinforced Nylon composite material to provide maximum strength.

The ball and seal ring are moulded in a PTFE filled polymer for lubricated, smooth continuous ease of operation. This material resists marine growth, such as barnacles, from seizing up the valve.

CAUTION NOT TO BE USED AS A DEDICATED FUEL VALVE

Features:

- Lightweight, corrosion resistant and safe from electrolysis
- Individually leak and pressure tested during manufacture
- Burst-rated to 750 PSI (5,170 kPa)
- Can be locked to comply with toilet waste outlet standards
- Available in parallel BSP and NPS thread forms, identified by markings on each threaded end
- Spanners available for hard-to-get-to installations
- OPEN/CLOSED positions marked for easy identification
- Frost-friendly and won't split like metallic ball valves can when frozen
- Removable handles to assist installation - fastened with a 316 Stainless Steel screw
- Available in position-monitored version
- T-handle or lever handle options.



Manual Ball Valve

When assembled with TruDesign Skin Fittings, our Ball Valves comply with the following standards:

- ISO 9093-2 Small Craft
 - Seacocks and through-hull fittings
- ABYC H-27 Seacocks, Thru-Hull Fittings**

**When assembled together with a TruDesign Skin Fitting and Load Bearing Collar. (See information sheet on our website).



Available in the following sizes

13mm	1/2"	38mm	1 1/2"
19mm	3/4"	50mm	2"
25mm	1"		
32mm	1 1/4"		



Monitored Ball Valve

Monitored Ball Valves provide position-monitoring of the seacock so you can easily see which valves are open and which are closed.

They can be wired to disable ignition on an engine switch until water intake ball valve is open.

When used in a holding tank pump-out system, it lets you know when the outlet is open to allow discharge.



Available in the following sizes

13mm	1/2"	32mm	1 1/4"
19mm	3/4"	38mm	1 1/2"
25mm	1"	50mm	2"



Monitor Panel

10-32VDC

Label pack supplied for custom naming

Load Bearing Collars

Load Bearing Collars are designed for use with TruDesign Skin Fittings and Ball Valves. The Collar enables compliance to ABYC H-27 standard for the entire assembly. (1/2"-2" models).

ABYC specification requires a 500lb (227kg) static force to be applied to the Tail end of the assembly, for a minimum of 30 seconds.

Provides strength and peace-of-mind & protects vulnerable areas, such as the exposed thread of the Skin Fitting, from being inadvertently struck by loose items.

Compact footprint - Designed to work within existing space confinements (is no larger in diameter than the ball valve and handle).

No need for additional bolts or fasteners through the hull - Unlike traditional flanged seacocks, the TruDesign collar works without needing to be fastened to the hull.

Ability to retrofit to existing assemblies - Can turn any TruDesign Skin Fitting / Ball Valve assembly into an ABYC H-27 compliant assembly.

Small Collar Fits

1/2" Ball Valve

3/4" Ball Valve

1" Ball Valve

Large Collar Fits

2" Ball Valve

Medium Collar Fits

1 1/4" Ball Valve

1 1/2" Ball Valve



DAME CATEGORY WINNER

3" Ball Valves & Fittings

Features:

- Manufactured from glass-reinforced Nylon composite – High strength, tough and light weight
- Large easy to turn handle
- Immune to corrosion & electrolysis.
- Can be locked in the closed position
- Electrically non-conductive
No electrical bonding
- Suitable for use on all hull types - aluminium, steel, wood or GRP
- The ball and sealing rings utilise a PTFE polymer to ensure a smooth action and minimal fouling of the internal ball
- Large operating temperature range – From -40°C to +110°C
- BSP Thread
- U.V resistant – No degradation from the sun's ultraviolet rays
- 100% leak tested before leaving factory.

3" Hi Flow Integrated Intake Strainer

Features:

- Hi Flow scoop designed with no restriction and flared intake channels to maximise flow efficiency yet prevent large debris entry
- Large undercuts on the base to assist with adhesive sealing against the hull surfaces
- Length is 160mm long (from the underside of the head) to cater for larger vessels
- Easy to clear large fins – no need to unscrew grate
- Can be painted over with anti-foul.





Connector 3" BSP 90° Female

- Ideal for above water line use where Ball Valve can be connected to run parallel to the hull
- Can be used with 75mm (3") and 63mm (2 1/2") Tail.



Tails (3" + 2 1/2")

- Two sizes of BSP Tails are offered to cater for 75mm (3") Hose or 63mm (2 1/2") Hose.



3" BSP Skin Fitting - Domed

Features:

- Large drip edge for above the water applications
- Length is 160mm long (from the underside of the head) to cater for larger vessels
- Can be painted over with anti-foul.

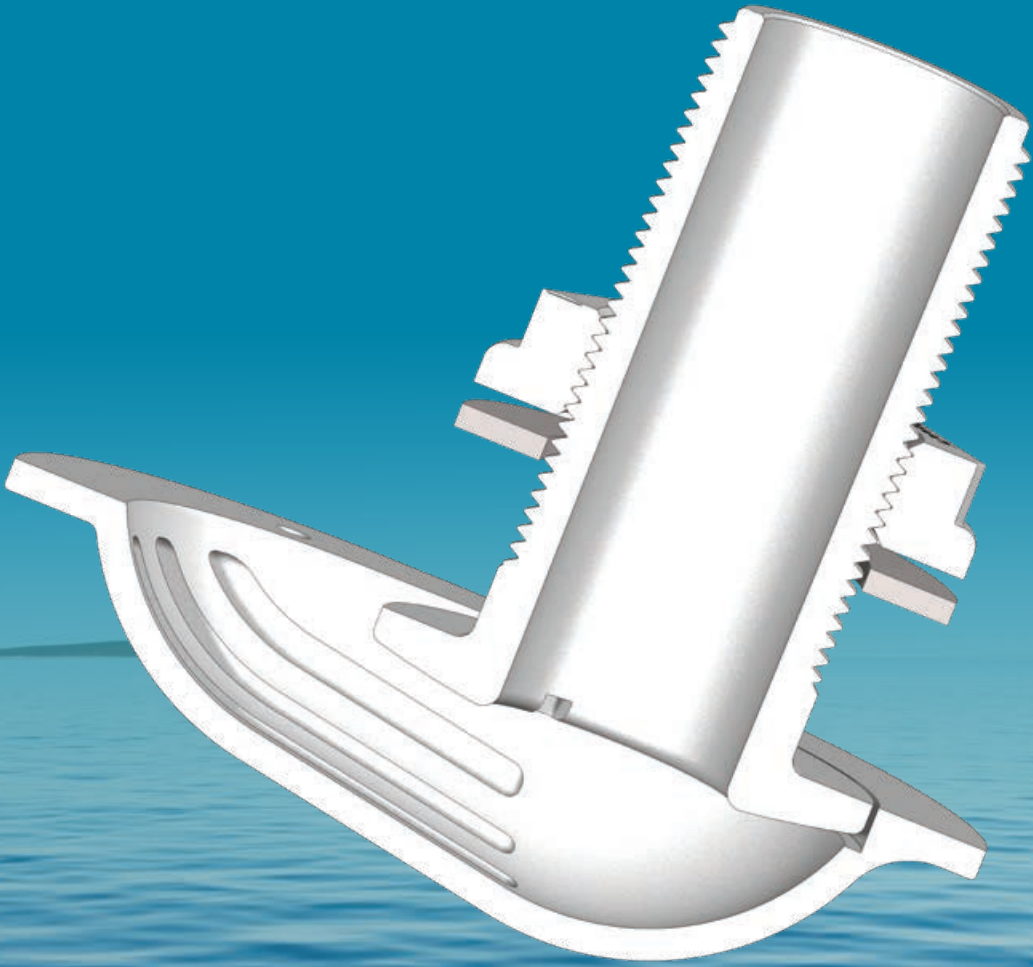

Intake Strainers

TruDesign strainers eliminate the corrosion and electrical bonding problems associated with metallic fittings. They can be painted over with anti-foul, and can be faired into the hull without concerns of corrosion.

Intake Strainer - Scoop

Designed to divert large objects away from water intakes while the vessel is moving.

- Helps eliminate problems with seaweed/seagrass, sticks or rubbish being sucked into engine intakes and blocking or clogging intake filters
- The strainer acts as a coarse first stage filter that is cleaned by water movement.

Available Sizes	Fits Skin Fitting
¾"	¾" and ½"
1 ¼"	1 ¼" and 1"
2"	2" and 1 ½"



Intake Strainer - Round

Designed for water intake applications where there is a risk of sucking in unwanted objects.

Available Size	Fits Skin Fitting
1 ¼"	1 ¼" or smaller



Aquavalves... the most versatile Y-Valve on the market.

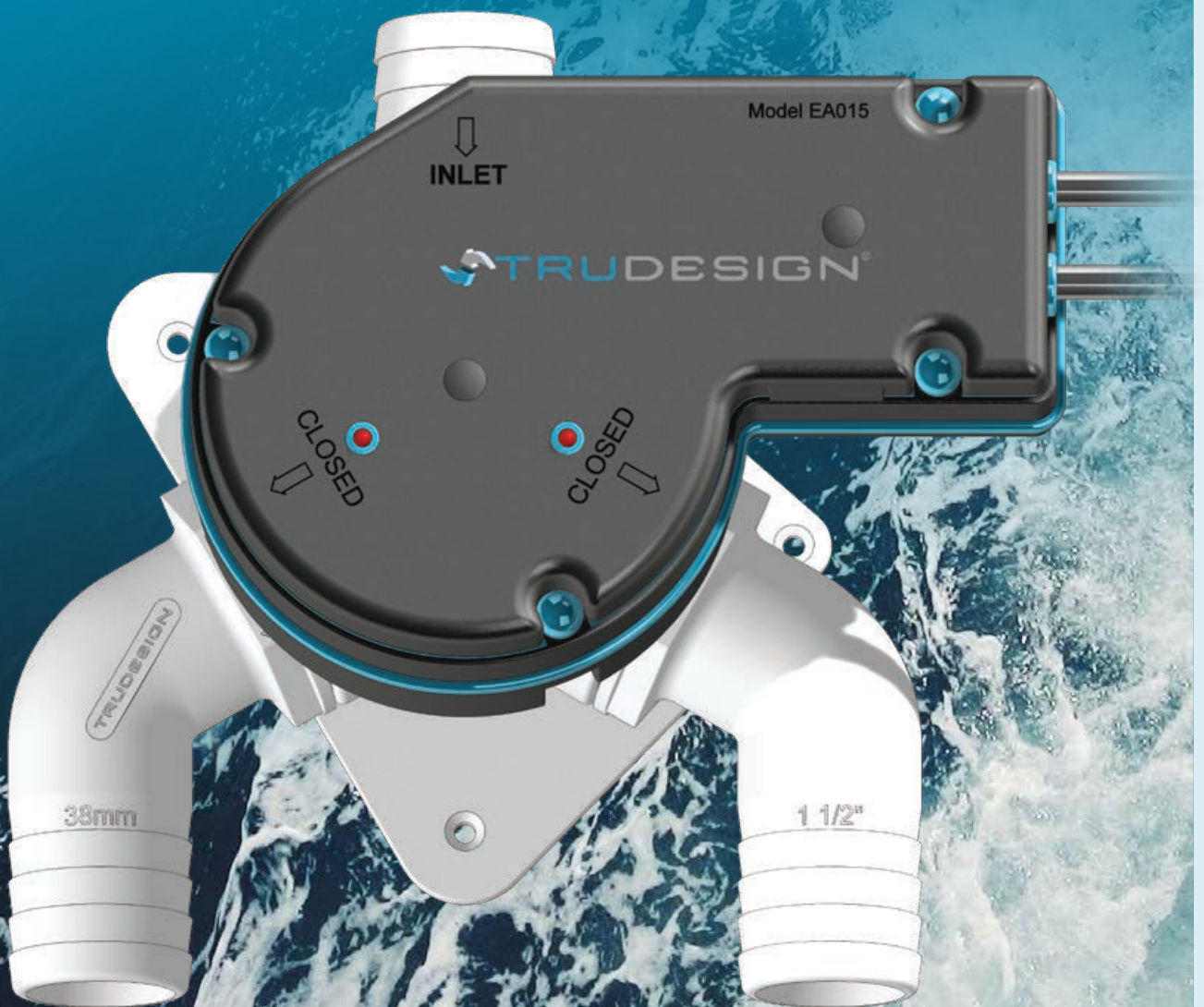

Typical Manual Aquavalve (Y valve) Installation

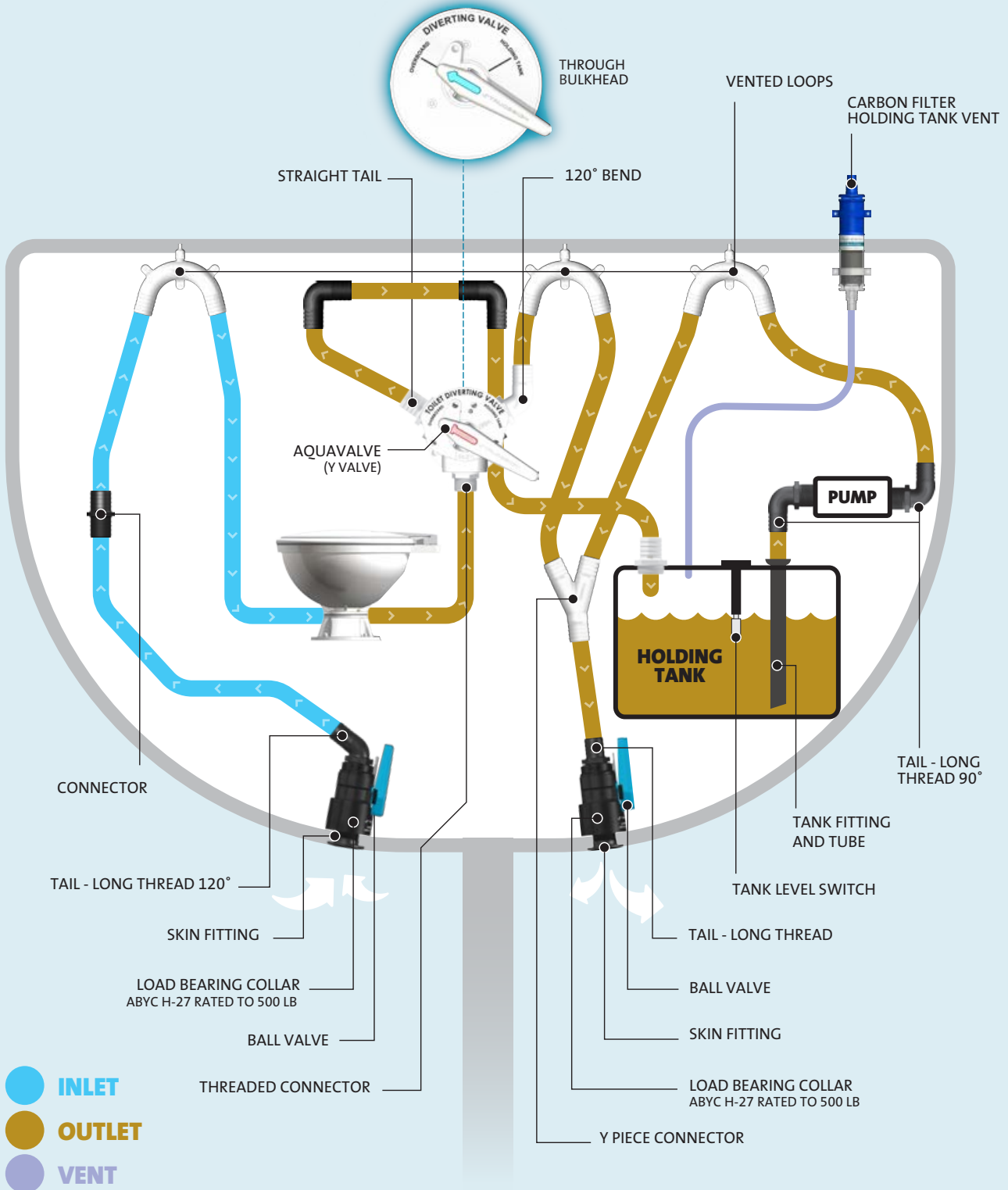

Manual Aquavalue (Y-Valve)

The TruDesign Aquavalue is designed for the diversion and control of the flow of effluent or water.

Used in marine toilet applications to divert the flow of effluent - in many countries this is governed by law. The effluent can be held in a holding tank for later discharge overboard or to a shore side facility.

The TruDesign Aquavalue is moulded from a glass-reinforced nylon composite. High strength, high-modulus glass fibres impregnated into the nylon provides dramatic strength, stiffness, toughness, and dimensional stability.

Features:

- Clear indication of which port is in the closed position
- Versatile - can connect 3/4" to 1 1/2" hose
- Easy mounting - screws directly to bulkhead or floor
- 316 Stainless Steel fastenings
- * Each valve is leak pressure tested during manufacture
- * Design burst pressure rating of 300 PSI (2,070 kPa)
- User serviceable - Full service and parts backup
- Lockable feature - no ability for accidental discharge
- Each valve supplied with spanner.

CAUTION
NOT TO BE
USED FOR
DIVERTING
FUELS

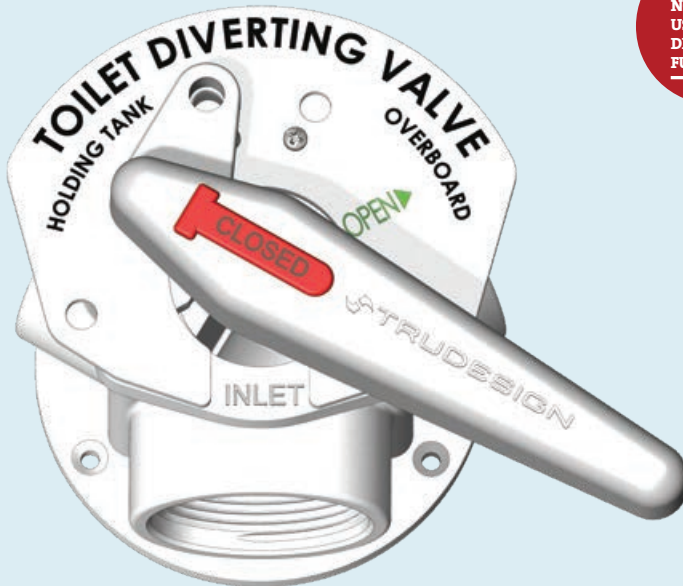

White Model **BSP**



Black Model **BSP**



Through Bulkhead Model **BSP**

Note: All three ports female 1 1/2" BSP Parallel threads

Electronic Aquavalve (Y-Valve)

The TruDesign Electronic Aquavalve allows remote "Push Button" diversion of effluent or water.

The TruDesign Electronic Aquavalve has been designed to allow the Diverting Valve to be operated from the Control Panel with the push of a button. LED's on the Control Panel clearly denote whether the Valve is in the "Holding Tank" or "Overboard" position.

The Electronic Aquavalve is supplied complete with the following:

- Electronic Aquavalve body EA015
- Control Panel CP05
- Aquavalve Spanner
- 5 metre length of 8 core cable complete with waterproof connection for Aquavalve and push in connector for control panel
- Maintenance grease
- Comprehensive Installation and Operator Instructions
- Features an electronic keypad lock to prevent accidental operation.

BSP

Electrical Specifications
Voltage 11-32 volts



The Electronic Aquavalve and Control Panel both carry an IP55 rating (dust and water spray proof). CE approved.

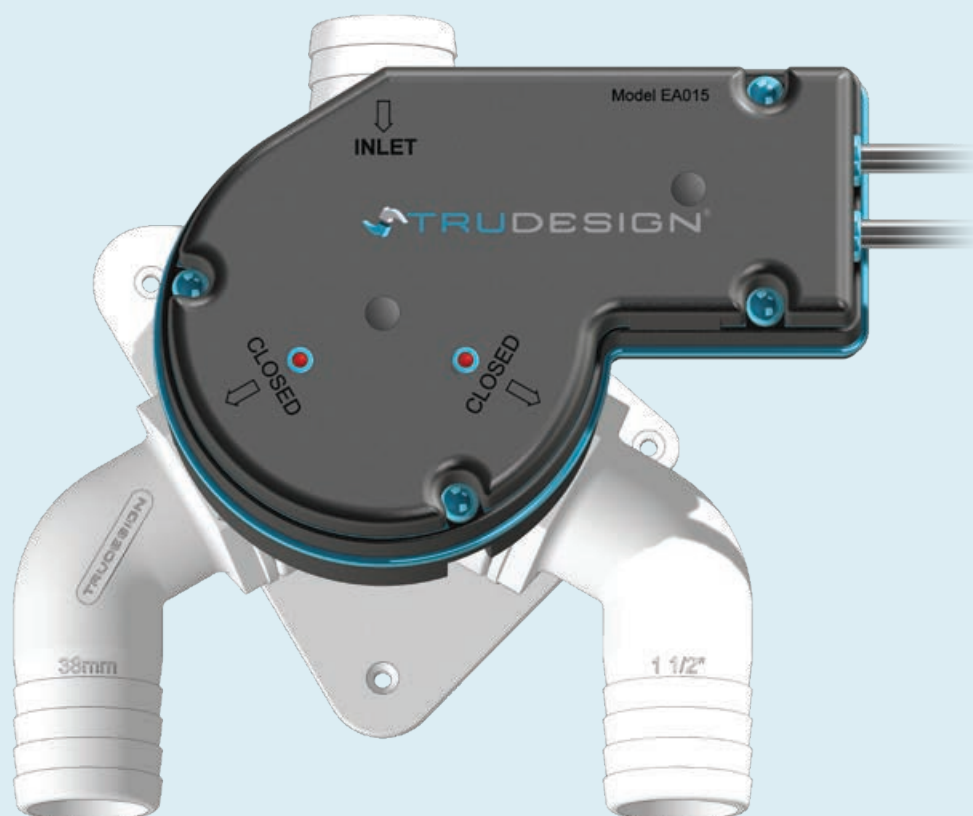

Aquavalve Versatility

The TruDesign Aquavalve is the most versatile diverting valve available. With the ability to mix and match fittings, adjust the angle of piping and flip the face plate to suit the installation, fitting a diverting valve into the confined spaces of marine plumbing is made easy.

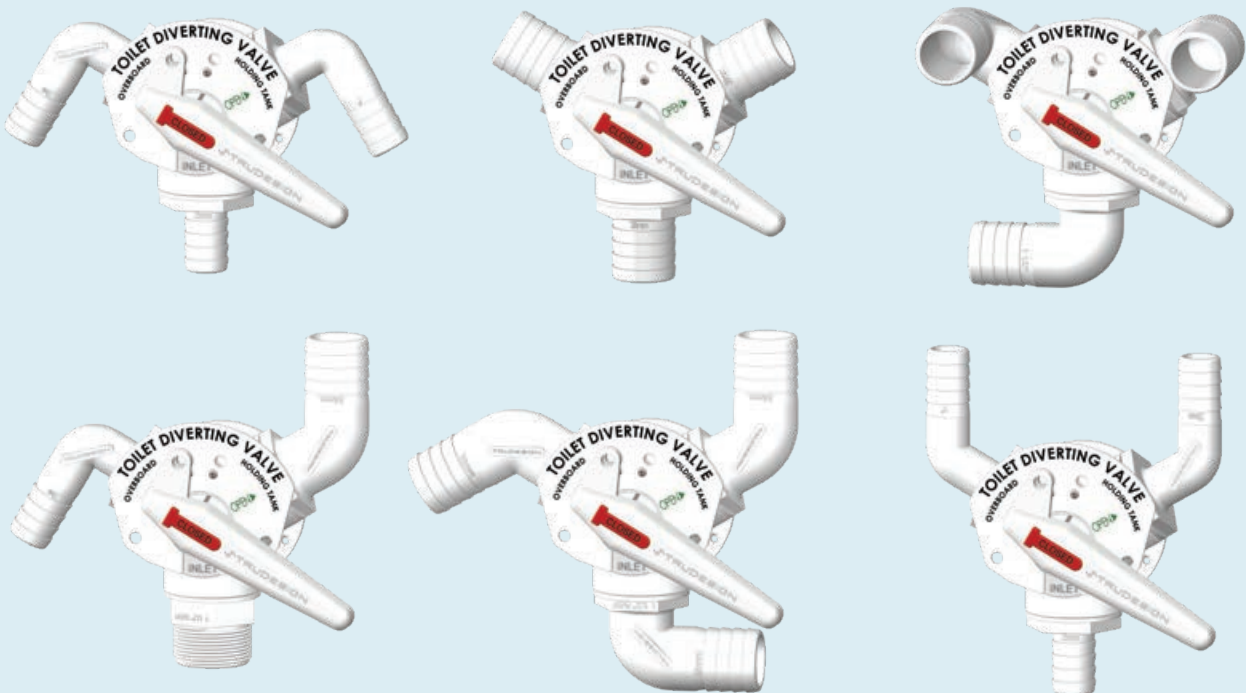

Through Bulkhead Fitting

The Through Bulkhead version allows the plumbing and valve body to be hidden behind a wall or panel.

The Aquavalve Through Bulkhead suits wall thicknesses up to 15mm. If your bulkhead is thicker than 15mm, the Extension Pack is available for walls up to 37mm.

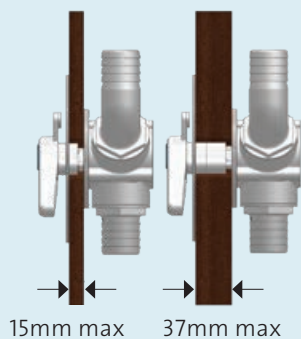

Reversible Faceplate

The reversible faceplate allows the user to install the Aquavalve in the most suitable way, then adjust the faceplate to suit the direction of plumbing hoses.

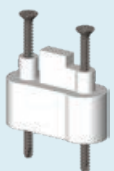

Aquavalue Fittings

A full range of tail fittings of different sizes and angles are available. Featuring male 1½” BSP Parallel threads designed for direct installation and sealing on the red gaskets included with the Aquavalue.

Tail sizes are available in common hose sizes from 19 – 38mm. Bends allow tidy routing of hoses and are supplied with a thicker seal option (Blue) which can be used in place of the Aquavalue’s red seals to allow fittings to be rotated to a more suitable position if needed.



BSP

Aquavalue Tails

Available in 4 sizes - Black & White

19mm	¾”
25mm	1”
32mm	1¼”
38mm	1½”



BSP

Aquavalue 120° Bend

Including Blue Seal - Black & White

25mm	1”
38mm	1½”



BSP

Aquavalue 90° Bend

Including Blue Seal - Black & White

25mm	1”
38mm	1½”



Plug **BSP**

Available in Black & White

1½” BSP

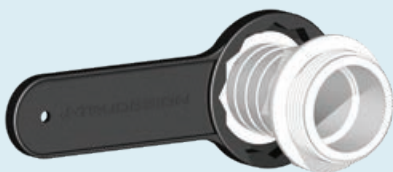

Aquavalue Spanner

Supplied with Aquavalue



Threaded Connector **BSP**

Available in Black & White

Allows direct connection of PVC piping. With 1½” BSP threads it can be used with Ball Valves, Aquavalves, and the Threaded T-Piece.

Carbon Filter

The Carbon Filter is designed for holding tank venting. It must be mounted vertically, or on an upward angle, and away from the tank to eliminate liquid contacting the carbon. Supplied complete with mounting bracket and hose tails 20mm, 25mm.





Threaded Connectors (Male)

TruDesign Threaded Connectors are the superior composite connection for connecting threaded fittings. Moulded from a glass-reinforced nylon composite they are high in strength, light in weight, and won't degrade or discolour over time.

They feature parallel threads for a strong, secure connection, reliable waterproof sealing, and flexibility to be able to orientate fittings to suit end-use operation – useful when space is restricted.

TruDesign fittings are chemically resistant, and eliminate the corrosion and electrical bonding problems associated with metallic fittings. Tails are designed for twin hose clamps and will not crush.



BSP NPS

Male-Tail 120° Bends

Thread Size	Tail Size
1"	25mm (1")
1¼"	32mm (1¼")
1½"	38mm (1½")
2"	50mm (2")



BSP NPS

Male-Tail 90° Bends

Thread Size	Tail Size
½"	13mm (½")
¾"	19mm (¾")
1"	25mm (1")
1¼"	32mm (1¼")
1½"	38mm (1½")
2"	50mm (2")

Unequal

½"	16mm (5/8")
1¼"	38mm (1½")



BSP NPS

Male-Tails Straight

Thread Size	Tail Size
½"	13mm (½")
¾"	19mm (¾")
1"	25mm (1")
1½"	32mm (1¼")
1½"	38mm (1½")
2"	50mm (2")
3"	63mm (2½") BSP only
3"	75mm (3") BSP only

Unequal

½"	16mm (5/8")
¾"	22mm (7/8")
1"	28mm (1 1/8")
1¼"	38mm (1½")
1½"	32mm (1¼")

Threaded Connectors (Female)

Note: for above waterline applications only (ISO and ABYC regulations require a Ball Valve attached directly to the Skin Fitting i.e. no other fittings should be installed between the two)

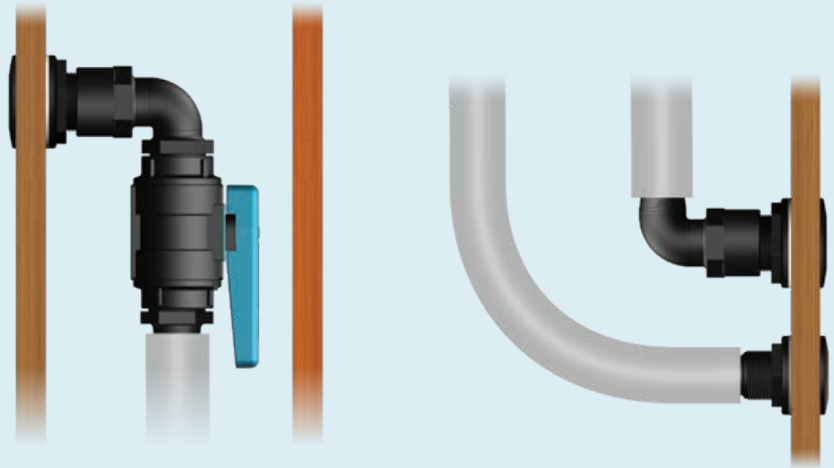

BSP NPS

Female-Tails Straight

Thread Size	Tail Size
3/4"	19mm
1"	25mm
1 1/4"	32mm
1 1/2"	38mm
2"	50mm
Unequal	
3/4"	22mm (7/8")
1"	28mm (1 1/8")
1 1/4"	38mm
1 1/2"	25mm
1 3/4"	38mm



BSP NPS

Female-Male 90° Bends

For Ball Valves in confined locations.

Female Thread	Male Thread
3/4"	3/4"
1"	1"
1 1/4"	1 1/4"
1 1/2"	1 1/2"
2"	2"
3"	3" BSP only



BSP NPS

Female-Tail 90° Bends

Helping to solve the problems of confined plumbing encountered in marine installations.

Thread Size	Tail Size
3/4"	19mm
1"	25mm
1 1/4"	32mm
1 1/2"	38mm
2"	50mm
Unequal	
1/2"	16mm (5/8")

T-Piece Connector BSP

A versatile building block, the TruDesign T-Piece Connector functions not only as a T-Piece but also as a manifold. This allows users to channel multiple drains to one outlet, eliminating the need for additional thru-hull fittings. T-Pieces simply daisy chain together to create a manifold system.

The flexibility of the TruDesign T-Piece Connector allows

- Operates as a simple T-Piece
- Operation as a manifold with an expandable number of inlet ports to meet the individual boat requirements
- Multiple sizes of inlet and outlet hose tail options. Offered in 3/4", 1", 1 1/4", 1 1/2" sizes.

The TruDesign T-Piece features two female parallel threads and one male which allow manifolds to be created simply by joining two or more parts together. It is useful for when taking multiple hose connections to a single ball valve and thru-hull fitting.

A typical application includes connecting all flybridge drains to one manifold before draining overboard. It's also commonly used for glycol/antifreeze flush through systems in preparation for winterization as well as in fresh water engine flush out systems. A plug can be installed in the female end of the T-Piece to work as an inspection port for looking through to the internals of the ball valve.



Universal Manifold

Features:

- Simple T-Piece with user selectable hose tails
- Expandable manifold – facilitates multiple drains to one over board point
- Multiple inlet port hose tail size & direction selection (Straight, 120° & 90°)
- Multiple end port hose tail size & direction selection (Straight, 120° & 90°).
- Connects directly to 1 1/2" Ball Valve or 1 1/2" Skin Fitting (Thru-Hull)
- Can orientate inlet and outlet ports at user selectable angles - facilitates neat hose connections
- Immune to corrosion & electrolysis – Long life with no decreased performance due to corrosion
- Chemical resistant – Unaffected by diesel, petrol and house-hold chemicals
- Large operating range – Suitable for all marine conditions from -40°C to +110°C.



Non-Return Valves

TruDesign Non-Return Valves are used in-line to prevent water backflow or siphoning. They are full flow with low cracking (opening) pressures.

Features:

- Manufactured from a UV stabilized glass-reinforced Nylon composite. High strength and lightweight. Can be used in direct sunlight
- High impact and tensile strength - "Water hammer safe" and insensitive to pressure shocks in the pipeline
- Stainless spring - No corrosion issues or risk of internal valve staying open
- Low cracking pressure - Minimal pressure required to open the valve with minimal restriction on flow-rate
- In-line fitting - Minimal installation room needed and no other fittings required
- Printed white arrow (opposite logo side) - Quick and easy identification of water flow direction.

Available in 6 sizes

19mm	3/4"
25mm	1"
28mm	1 1/8"
32mm	1 1/4"
38mm	1 1/2"
50mm	2"

Non-Return Valves Threaded

25mm	1"
38mm	1 1/2"



Technical information available on web at trudesignplastics.com

High quality, composite, free flow vented loops.

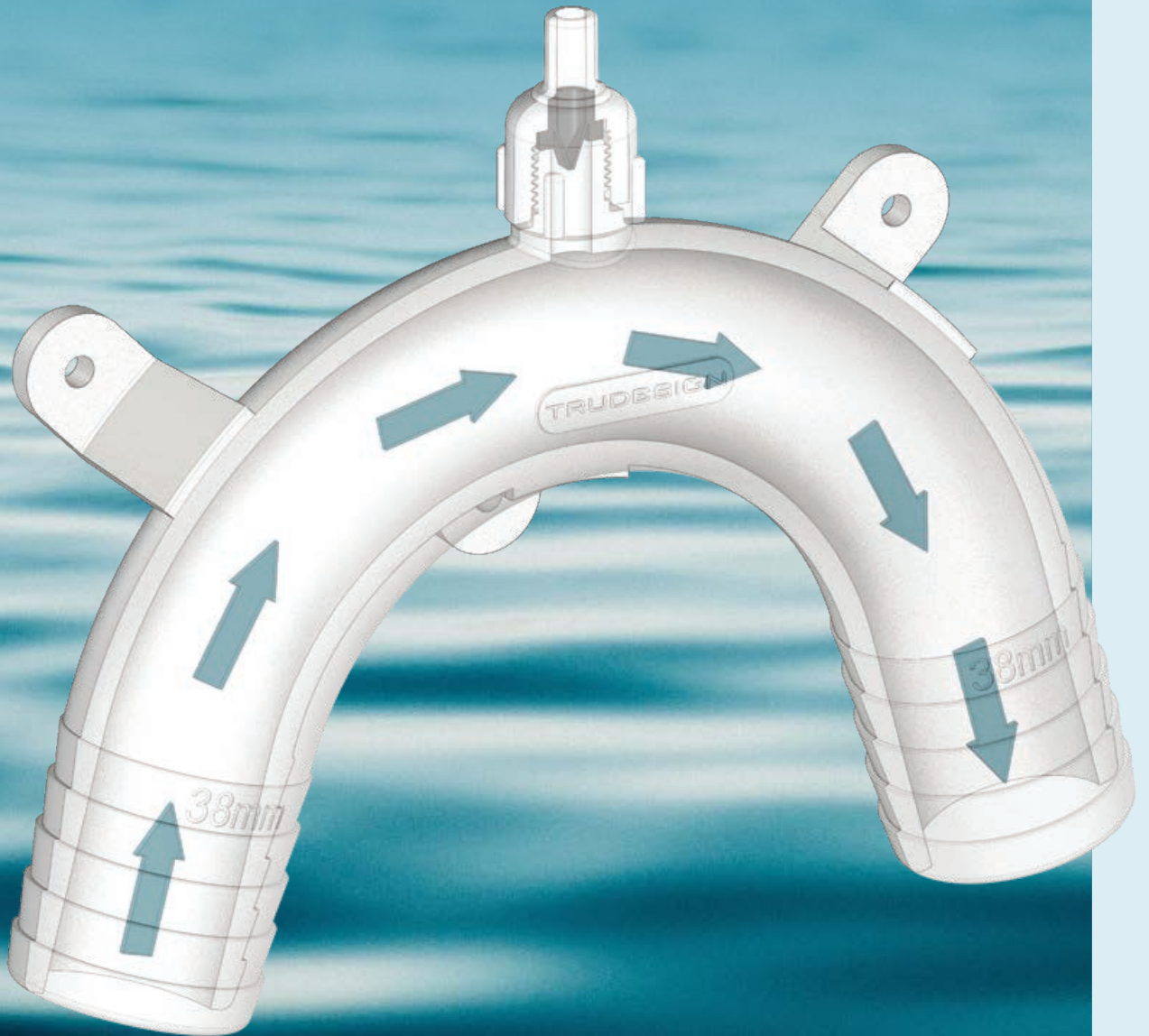

Vented Loops

Vented loops can stop the dangerous siphoning back of fluids from tank to tank or into toilets and small engine cooling systems. The TruDesign Vented loop is the only siphon-break fitting with no restriction through the entire internal diameter.

Made of corrosion-resistant composite material which prevents degradation and leaks that occur with cheaper material products.

The simple one way breather valve at the top of the vented loop allows air to enter the line when not in use, thereby preventing siphoning - and yet seals when water or waste passes through the loop.

Available in 3 sizes - Black & White

19mm	3/4"
25mm	1"
38mm	1 1/2"

Used in:

- Toilet discharge applications
- Bilge pump outlet overboard
- Toilet inlet applications
- Genset or small engine inlet cooling water systems
- Air conditioners
- Ballast tanks.

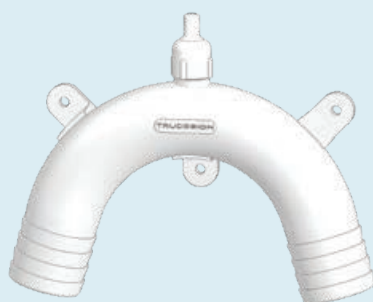

Vented Loops with Solenoid (electric toilets)

The extra inlet water suction generated by electric toilets will often open the duckbill valve in the standard vented loops - drawing in air and preventing pump priming and full flush.

Installing a solenoid operated vented loop on the inlet hose will ensure maximum electric toilet performance and primeability. Simply wire in parallel to the toilet's electric motor ensuring the valve is closed when water is being sucked "in" and venting when the motor is off.

The solenoid will close the air valve only when the pump is running.

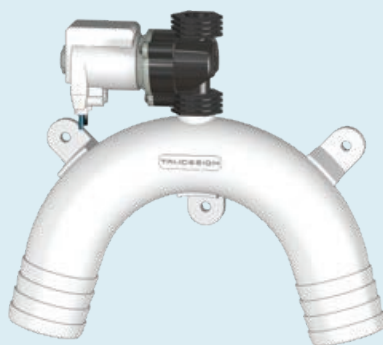

Available in 3 sizes - White

19mm	3/4"
25mm	1"
38mm	1 1/2"

- Available in 12VDC / 24VDC
- Power Consumption (Upon energizing) 400mA

Spare part kits

Contains Valve, Cap & Peg for clearing of vent hole.





Hose Connectors

Moulded from a glass reinforced nylon composite they are high in strength, light in weight, and immune to electrolysis or house-hold chemical degradation.

Y-Pieces

Y-Pieces are available in a variety of sizes to allow two drain hoses to merge into one line.

The Y configuration minimizes clogging and facilitates flow.

Designed for use with twin hose clamps and will not crush.

Available Sizes - White

19mm - 19mm - 19mm	$\frac{3}{4}$ " - $\frac{3}{4}$ " - $\frac{3}{4}$ "
25mm - 25mm - 25mm	1" - 1" - 1"
32mm - 32mm - 32mm	1 $\frac{1}{4}$ " - 1 $\frac{1}{4}$ " - 1 $\frac{1}{4}$ "
38mm - 38mm - 38mm	1 $\frac{1}{2}$ " - 1 $\frac{1}{2}$ " - 1 $\frac{1}{2}$ "

Unequal

19mm - 19mm - 25mm	$\frac{3}{4}$ " - $\frac{3}{4}$ " - 1"
25mm - 25mm - 38mm	1" - 1" - 1 $\frac{1}{2}$ "

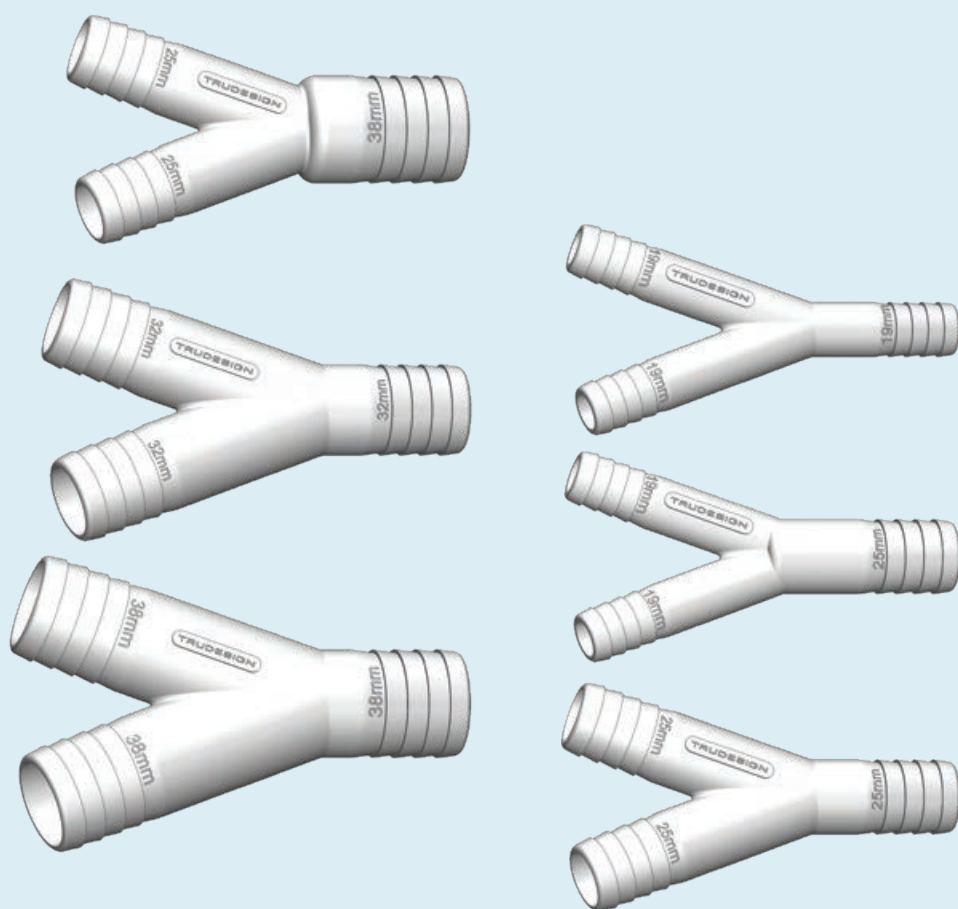

Hose Connectors



90° Bend Connectors

Hose connectors to facilitate tidy routing of hoses round 90° corners, reducing crimped hoses and stress on hoses.

Available Sizes - Black & White

19mm	3/4"
25mm	1"
38mm	1 1/2"
50mm	2"



Connectors

Simple straight connectors for joining two hoses of the same size.

Available Sizes - Black

1/2"	13mm
3/4"	19mm
1"	25mm
1 1/8"	28mm
1 1/4"	32mm
1 1/2"	38mm
2"	50mm



Reducers

TruDesign Reducers are the superior composite connection for linking 2 hoses of different sizes.

Available Sizes - White

3/4" - 1/2"	19-13mm
3/4" - 5/8"	19-16mm
1" - 1/2"	25-13mm
1" - 3/4"	25-19mm
1 1/4" - 1"	32-25mm
1 1/2" - 1"	38-25mm
1 1/2" - 1 1/4"	38-32mm

Threaded Tubes

Designed for the secure routing of plumbing hoses or wiring through bulk heads or internal cabinetry.

Description

Tube Threaded 1" BSP 140mm long

Tube Threaded 1 1/2" BSP 140mm long

Features:

- Comes in two sizes of diameter – 1" and 1 1/2"
- Total length 140mm (5 1/2")
- Comes complete with two nuts and two backing washers
- Eliminates chafing of plumbing hoses or wiring when passing through Bulk Heads
- Connects with TruDesign Female Hose Tails to allow routing of hoses to fit neatly into place
- Can be cut to length to suit thickness of Bulk Head.

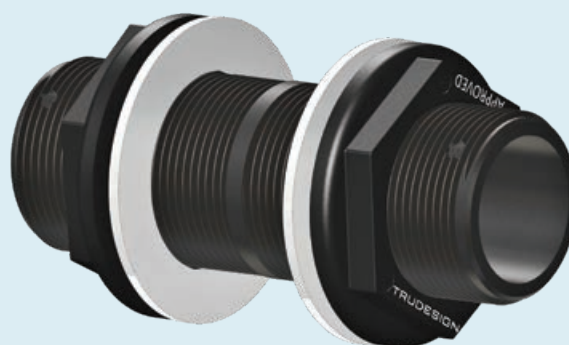

Bulkhead Flange

The TruDesign Bulk Head Flange is designed to allow smooth routing of cables or plumbing hoses through bulk heads, helping to minimize abrasion.

Description

Internal Diameter - 49mm

Mounting Hole Diameter - 60mm and depth from flange -12mm

Overall Flange Diameter - 93mm



Saddle Base & Clip Fastening Systems

TruDesign Saddle Base and Clip System is designed to provide strong and compact routing of cables or hoses without the need for fasteners.

Features

- Large undercut dovetail grooves enlarge the available bonding surface area, resulting in tremendous holding power to GRP, composite, wood hulls or bulk heads
- No need for stainless steel fasteners saving costs and preserving the integrity of the hull
- The cable tie slot in the Saddle Base enables a standalone method of bundling cables and plumbing hoses
- Four Saddle Clip options are also available. They simply click onto the Saddle Base and can hold standard hose sizes from 13mm to 50mm
- The Saddle Clips and Cable ties can be used together to enhance the tiedown strength. Or route both cables and hoses along the same pathway.

Saddle Clips Available In Four Sizes

13mm	1/2"
20mm	3/4"
28mm	1 1/8"
38mm	1 1/2"



Level Sensors & Tank Monitors

Tank Monitor Panel

The tank monitor has been designed as a simple alarm system to indicate when a marine sewage or fresh water holding tank is nearly full.



- The system is designed to operate on 12/24 Volt DC
- Comprehensive installation instructions supplied
- 316 Stainless Steel fastenings
- Internal wire tinned to protect against corrosion
- Each unit individually circuit tested
- Full service and parts backup
- Easily changed to indicate empty or full.



Tank Sensor Switch (Short)



Tank Sensor Switch (Long)

Tank Fittings BSP

Tank fittings can be utilised for installation into a holding tank. Tank fittings are a customised version of our standard components and accommodate the tank fitting tube. Thread size 1 1/2"

Tank Fitting - 120°

Available Sizes - White

25mm Hose Adaptor	(1")
38mm Hose Adaptor	(1 1/2")



Tank Fitting - 90°

Available Sizes - White

25mm Hose Adaptor	(1")
38mm Hose Adaptor	(1 1/2")



Tank Fitting Straight

Available Sizes - White

19mm (3/4")
25mm (1")
32mm (1 1/4")
38mm (1 1/2")



Tank Fitting Tubes

205mm (8")
490mm (19")



Threaded Vent Plug

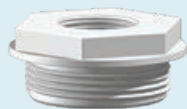

1 1/2" BSP External Thread
3/4" BSP Internal Thread

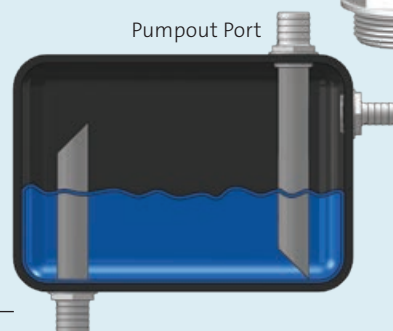

Marina & Yacht Wash-down Nozzles



Hose Nozzles

The TruDesign range of hose nozzles are durable yet lightweight. Made from high impact strength polycarbonate polymer, they can be adjusted easily and smoothly with a twist of the wrist for a strong jet throw, cone spray or fog pattern.



Large Powerjet

- Approved for use with fire hoses on surveyed vessels in NZ
- Typical flowrate of up to 300 Litres/min

1½" BSP - 4 sizes of tail options available (38, 32, 25, and 19mm).



Small Powerjet

- Approved for use with fire hoses on surveyed vessels in NZ
- Typical flowrate of up to 100 Litres/min

1" BSP - 3 sizes of tail options available (32, 25, and 19mm).



Hose Reel Nozzle

- Meets both New Zealand & Australian Fire Hose Reel Standards
- Typical flowrate of up to 50 Litres/min

¾" BSP - 3 sizes of tail options available (25, 19, and 13mm) plus the Tail Snap.

Tail Snap

¾" BSP Thread



Powerspray Nozzle

Made from super tough Nylon 6, Powerspray Nozzles are ideal for all Marine and Industrial spraying applications. Typical flowrate of up to 42 Litres/min

¾" BSP - 3 sizes of tail options available (25, 19, and 13mm) plus the Tail Snap.



Hose Clamps

Low-profile composite material hose clamps provide excellent hose clamping with no sharp edges meaning they won't scratch or damage decks or hardware.

NB: Not suitable for underwater applications.



Available sizes:

13mm (½")

19mm (¾")

25mm (1")

32mm (1¼")

38mm (1½")



Installation Tools / Misc



Skin Fitting Installation Tools

These unique, world-first products allow installation to be carried out by one individual. Simply insert from the flanged end and turn until it 'Clicks' into position. It can then be offered into the hull from the outside. Once inside the boat the Skin Fitting Washer and Nut can then be fitted whilst stopping the Skin Fitting from turning.

Once finished, they can be clicked out to be used again.



Marine Hinge

Composite material for strength and durability.

Available in Black & White including 316 S/S Hinge Pin.

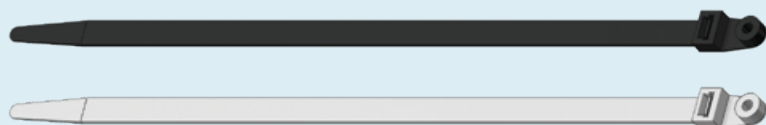

Multistrap

The Multistrap has been designed to secure electrical cable looms and plumbing hoses by utilising the unique screw hole. Moulded in Nylon 6, they are designed to support up to 5 kg in weight. Available in packs of 10 or 50 in both black & white. Maximum circumference: 270mm/width:10mm.

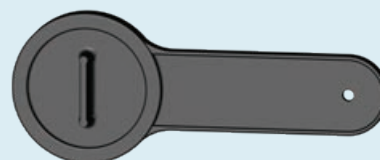

Fuel / Water Spanner

Ideal special purpose Spanner for fuel & water deck fittings.



Mould Plugs for Recessed Skin Fitting

Designed to form the recess in a fibreglass (GRP) hull that is required for the flush fitment of a TruDesign Recessed Skin Fitting.

Available sizes.

3/4" / 1" / 1 1/4" / 1 1/2" Recessed



Countersunk Washers

20 Pack - Black or white

Available in two sizes: 6mm & 4.7mm



Are your marine plumbing fittings compliant?



ISO Standards

ISO 9093-2:2002

Small craft - Seacocks and through hull fittings - Part 2: Non-metallic.

TruDesign Skin Fittings and Ball Valves are certified by the Bureau Veritas and the International Marine Certification Institute (IMCI) to meet ISO 9093-2.

Testing

To meet the requirements of ISO 9093-2 the Ball Valves and Skin Fittings must continue to seal and be operable after a 1,500 N (150kg) load is applied 20 mm to the most inward part of the assembly 10 times.

Compliance

TruDesign products that comply with ISO 9093-2 are (3/4" to 3" models)

1. Domed and Recessed Skin Fittings
2. Long Skin Fittings
3. Ball Valves – BSP & NPS
4. Skin Fittings with Tail

ISO 8099:2000

Small craft - Toilet waste retention systems

TruDesign Ball Valves help boat owners and builders meet the requirements of ISO 8099 requiring the toilet waste outlet to be locked in the closed position.



USA Standards

ABYC H-27

ABYC, the American Boat and Yacht Council are an organization which provides standards and recommendations in the USA.

The ABYC standard H-27 — Seacocks, Thru-Hull Fittings, and Drain Plugs is a guide for the selection of materials, design, construction, and installation of seacocks, thru-hull connections, drain plugs, and other fittings that penetrate the hull at or below the maximum-heel waterline.

This standard references UL 1121, Marine Through-Hull Fittings and Sea-Valves which also covers above water applications.

US Coast Guard Fire Test #183.590

(min. 648 degrees C within 1 inch of component for 2.5 minutes)
Pass - Ball Valve Fully functional (with no leaks).

USCG

US Coast Guard regulations are a legal requirement of operating a vessel in US waters.

33 CFR Ch. I (7–1–10 Edition) PART 159-MARINE SANITATION DEVICES states.

When operating a vessel on a body of water where the discharge of untreated sewage is prohibited by the Environmental Protection Agency under 40 CFR 140.3, the operator must secure each Type III device in a manner which prevents discharge of sewage. Acceptable methods of securing the device include;

1. Closing each valve leading to an overboard discharge and removing the handle;
2. Padlocking each valve leading to an overboard discharge in the closed position; or

3. Using a non-releasable wire-tie to hold each valve leading to an overboard discharge in the closed position.

The Aquavalue, Electronic Aquavalue and Ball Valves all provide the ability to be locked in the closed position thereby preventing discharge from a Type III device (holding tank or similar).

Distributor Support



Distributor Page

<http://www.truedesignplastics.com/marine/distributors>



Detailed Catalogue

- Pictorial catalogue for easy navigation
- Spreadsheet pricing including barcodes for input into POS systems



Packaging Options

Available in printed zip-lock pouches for easy and effective display. Product can be supplied loose for OEM supply or bulk display.

* some products are supplied packaged due to logistical/standards requirements.



Product Info Sheets

Comprehensive Product Info Sheets are available for all products. These include important information such as specifications, dimensions and installation instructions.



Drop Box Image Library

All product images are available as renders for high quality presentations. Logos supplied in multiple formats with associated branding guidelines.

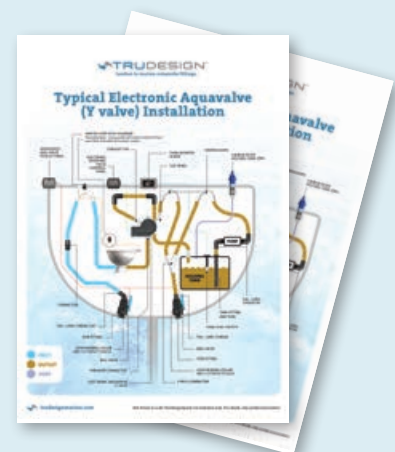

Installation Posters

For Manual and Electronic Aquavalue.

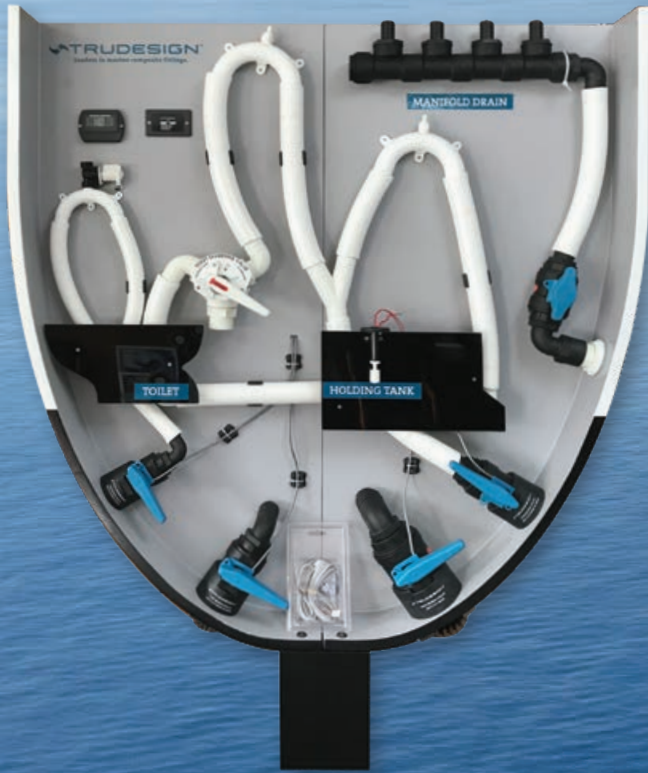

Product Display

Interactive display of a range of products arranged in a boat cross-section to better visualise product usage.



Head Office

243 Ti Rakau Drive, East Tamaki,
Auckland 2013, New Zealand
Phone: + 64 9 274-5792
Fax + 64 9 274-6722

Postal Address

PO Box 14-555, Panmure, 1741
Auckland, New Zealand

Email

support@trudesignplastics.com

Find us online:

trudesignplastics.com

